

RVX2 Brackets

RVX2-WALL-G RVX2-WALL-B

Available as standard in light-grey or black, the Redvision Wall bracket provides easy, elegant mounting for X2 COMBAT cameras. The Wall bracket has an interface for the camera safety bond. This bracket allows upright or conventional hanging configuration.

Specifications

Zinc-plated, Steel bracket with powder-coat finish

4" PCD mount, allowing for M8 fixings

Cable access: M20 standard gland-entry point or through base

Colours: RAL 7035 light-grey, RAL 9005 Black, or Custom RAL

Weight: 2.2kg

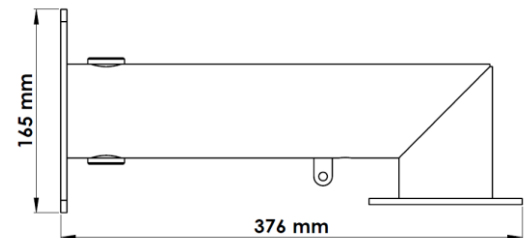

RVX2-SWAN-G RVX2-SWAN-B

The Redvision Swan-neck provides traditional type mounting of an X2 COMBAT in hanging dome configuration. The mount plate offers holes and slots for flexible positioning, on a 4" PCD, compatible with industry-standard CCTV masts and towers. The Swan-neck has an interface for the camera safety bond.

Specifications

Zinc-plated, Steel bracket with powder-coat finish

4" PCD mount, allowing for M8 fixings

Cable access: M20 standard gland-entry point or through base

Colours: RAL 7035 light-grey, RAL 9005 Black, or Custom RAL

Weight: 4.5kg

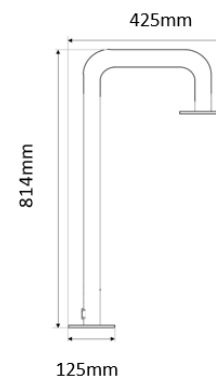
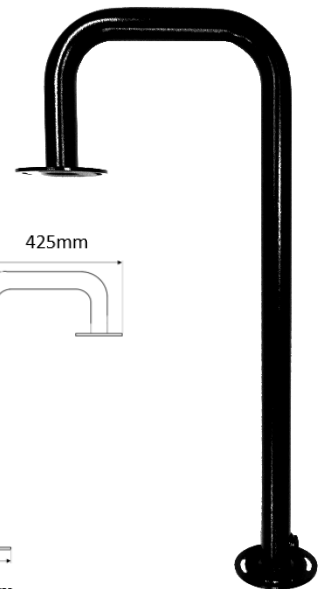

RVX2-STANDOFF-G RVX2-STANDOFF-B

The Redvision Standoff bracket is designed for upright tower-top mounting, providing a full 360° unobstructed view. The Standoff can also be used for traditional hanging configuration. 4" PCD base offers full compatibility with industry-standard towers and poles. The Standoff bracket has an interface for the camera safety bond.

Specifications

- Zinc-plated, Steel bracket with powder-coat finish
- 4" PCD mount, allowing for M8 fixings
- Cable access: M20 standard gland-entry point or through base
- Colours: RAL 7035 light-grey, RAL 9005 Black, or Custom RAL
- Weight: 1.3kg

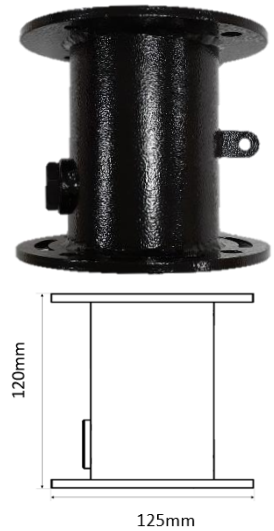

RVX2-CNR-G RVX2-CNR-B

The Redvision Corner bracket can be used with the RVX2-WALL bracket to provide simple and elegant corner mounting for X2 COMBAT cameras, in upright or hanging dome configurations.

Specifications

- Heavy-duty powder-coated steel construction
- Cable-managed through bracket
- Interfaces with RVX2-WALL
- Colours: RAL 7035 light-grey, RAL 9005 Black, or Custom RAL
- Weight: 1.5kg

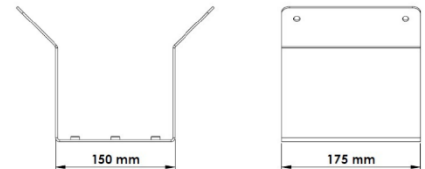
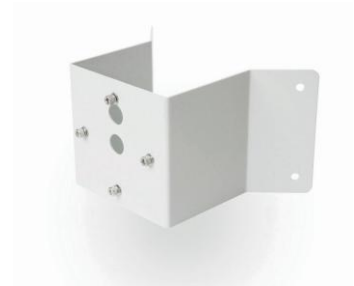

RVX2-POLE-G RVX2-POLE-B

Sturdy, external double pole-clamp fixes to pole diameters from 60mm to 90mm. To facilitate mounting an X2 COMBAT camera to the Pole bracket, an RVX2-WALL bracket is also required.

Specifications

- Heavy-duty steel plate construction
- Zinc plate and powder coat finish
- Clamps to poles 60mm-90mm
- Supports up to 2 cameras
- Colours: RAL 7035 light-grey, RAL 9005 Black, or Custom RAL
- Weight: 1.5kg

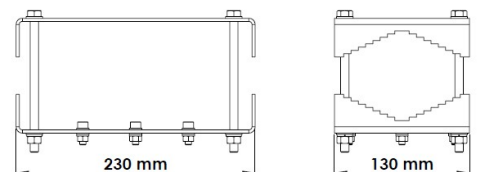

RVX2-VISOR-G

RVX2-VISOR-B

RVX2-VISOR-HF-G

RVX2-VISOR-HF-B

RVX2-VISOR option available for cameras installed as upright PTZs. The visor protects the camera from sun glare, rain and dirt build-up forming on the window. The visor aids image quality in challenging environments and reduces cleaning requirements. The -HF option includes a factory fitted, multiple anti-perch spike.

Specifications

Powder-coated aluminium construction

Factory or retro-fit option

Protects window against sun glare and rain

Colours: RAL 7035 light-grey, RAL 9005 Black, or Custom RAL

Weight: 0.1kg



RVX2-WASH

Redvision's washer nozzle option is mounted to the base of the X2 COMBAT camera. Compatible with standard CCTV wash pump systems, the control is via a dedicated relay output on any X2 COMBAT ALARM model.

Specifications

Stainless-Steel construction

Wash output control via X2 COMBAT ALARM model

Set wash position via preset

System compatible with standard wash pumps

Weight: 0.1kg

