

RVX4 Brackets

RVX4-WALL-G RVX4-WALL-B

Available as standard in light-grey or black, the Redvision Wall bracket provides easy, elegant mounting for X4 COMMANDER cameras. The Wall bracket has an interface for the camera safety bond. This bracket allows upright or conventional hanging configuration.

Specifications

Zinc-plated, Steel bracket with powder-coat finish

4" PCD mount, allowing for M8 fixings

Cable access: M20 standard gland-entry point or through base

Colours: RAL 7035 light-grey, RAL 9005 Black, or Custom RAL

Weight: 2.2kg

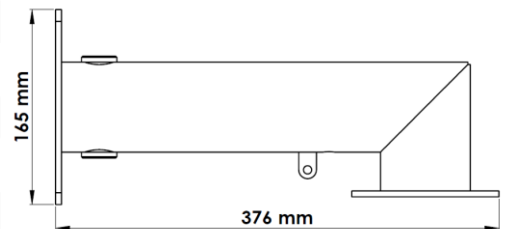

RVX4-SWAN-G RVX4-SWAN-B

The Redvision Swan-neck provides traditional type mounting of an X4 COMMANDER in hanging dome configuration. The mount plate offers holes and slots for flexible positioning, on a 4" PCD, compatible with industry-standard CCTV masts and towers. The Swan-neck has an interface for the camera safety bond.

Specifications

Zinc-plated, Steel bracket with powder-coat finish

4" PCD mount, allowing for M8 fixings

Cable access: M20 standard gland-entry point or through base

Colours: RAL 7035 light-grey, RAL 9005 Black, or Custom RAL

Weight: 4.5kg

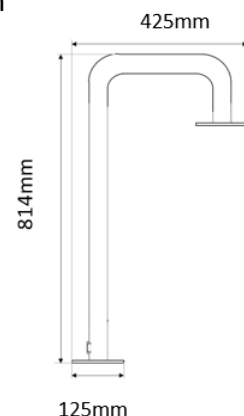
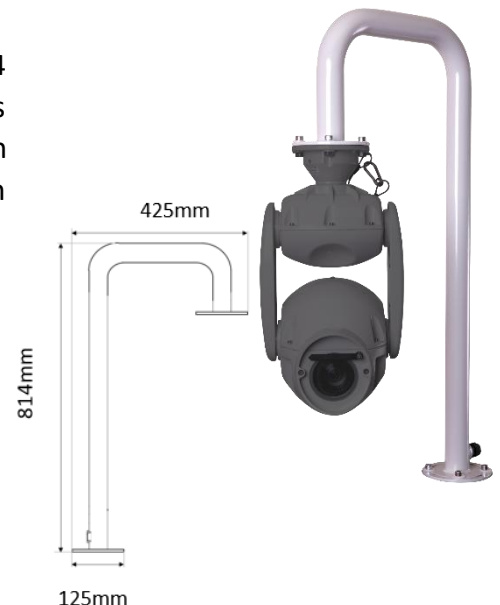

RVX4-STANDOFF-G RVX4-STANDOFF-B

The Redvision Standoff bracket is designed for upright tower-top mounting, providing a full 360° unobstructed view. The Standoff can also be used for traditional hanging configuration. 4" PCD base offers full compatibility with industry-standard towers and poles. The Standoff bracket has an interface for the camera safety bond.

Specifications

- Zinc-plated, Steel bracket with powder-coat finish
- 4" PCD mount, allowing for M8 fixings
- Cable access: M20 standard gland-entry point or through base
- Colours: RAL 7035 light-grey, RAL 9005 Black, or Custom RAL
- Weight: 1.3kg

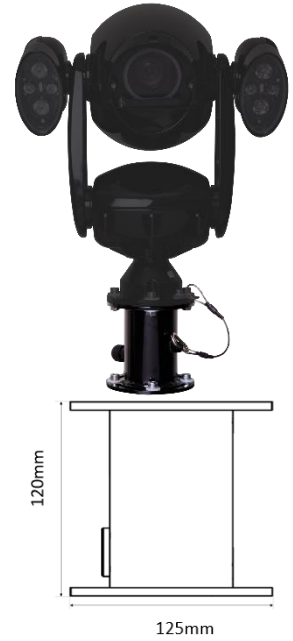

RVX4-CNR-G RVX4-CNR-B

The Redvision Corner bracket can be used with the RVX4-WALL bracket to provide simple and elegant corner mounting for X4 COMMANDER cameras, in upright or hanging dome configurations.

Specifications

- Heavy-duty powder-coated steel construction
- Cable-managed through bracket
- Interfaces with RVX2-WALL
- Colours: RAL 7035 light-grey, RAL 9005 Black, or Custom RAL
- Weight: 1.5kg

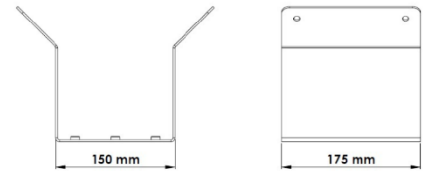
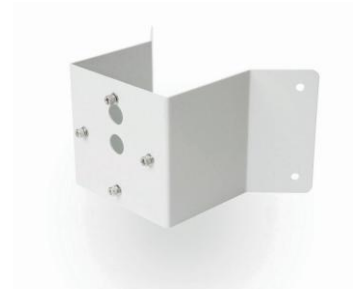

RVX4-POLE-G RVX4-POLE-B

Sturdy, external double pole-clamp fixes to pole diameters from 60mm to 90mm. To facilitate mounting an X4 COMMANDER camera to the Pole bracket, an RVX4-WALL bracket is also required.

Specifications

- Heavy-duty steel plate construction
- Zinc plate and powder coat finish
- Clamps to poles 60mm-90mm
- Supports up to 2 cameras
- Colours: RAL 7035 light-grey, RAL 9005 Black, or Custom RAL
- Weight: 1.5kg

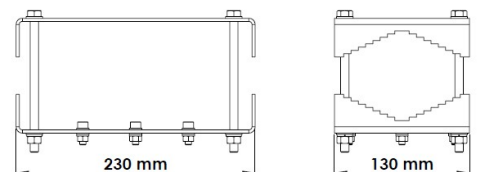

RVX4-BIRD-SPIKE

RVX4-BIRD-SPIKE option available for cameras installed as upright PTZs. The multiple bird spike acts to prevent birds from perching on top of the camera when mounted in an upright position.

Specifications

Powder-coated aluminium construction

Deters perching of birds

Colour: RAL 9005 Black

Weight: 0.1kg



RVX4-WASH

Redvision's washer nozzle option is mounted to the base of the X4 COMMANDER camera. Compatible with standard CCTV wash pump systems, the control is via a dedicated relay output on any X4 COMMANDER ALARM model.

Specifications

Stainless-Steel construction

Wash output control via X4 COMMANDER ALARM model

Set wash position via preset

System compatible with standard wash pumps

Weight: 0.1kg

